

WARD INSTALLATION

Round CRD Installation Instructions FOR USE IN WOOD AND GYPSUM CONSTRUCTION PARTITIONS

55

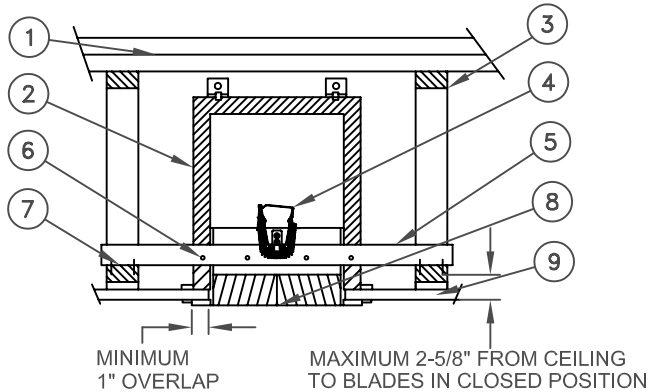

ITEM DESCRIPTION

1. FLOOR/ROOF DECKING
2. INSULATED PLENUM BOX
3. FLOOR OR CEILING TRUSSES
4. MODEL 55 CEILING RADIATION DAMPER
5. MOUNTING ANGLES (1-1/2" x 1-1/2" x 18 GA MINIMUM)
6. ANGLE TO BOX FASTENERS (SCREWS, RIVETS, SPOT WELDS)
7. ANGLE TO TRUSS FASTENERS (NAILS OR SCREWS)
8. MOUNTED STEEL GRILLE, DIFFUSER, OR DUCT DROP
9. CEILING: GYPSUM WALLBOARD

OPTION 1
90° ANGLE

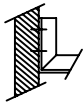

OPTION 2
FLUSH MOUNT

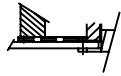

OPTION 3
DROP CEILING

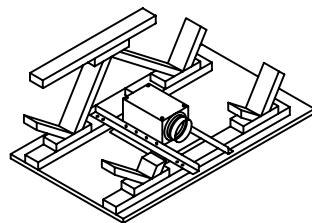
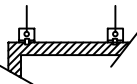

MODEL 55 DUCTED 90° THRU TRUSSES

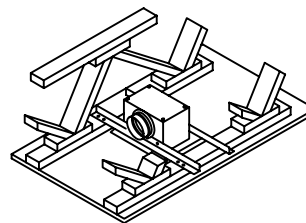

MODEL 55 DUCTED 90° PARALLEL TO TRUSSES

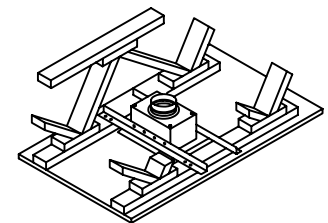

MODEL 55 STRAIGHT DUCTED

Model 55LP and 55EA dampers are classified to UL 555C as 3 hour or less heat barriers illustrated in the UL Fire Resistance Directory. Model 55LP and 55EA damper - plenum box assemblies are ARL Listed to be in compliance with UL 555C. Ceiling dampers and the associated components (diffusers, grilles, ducts, etc.) which are to be constructed of steel are installed in the ceiling to maintain the hourly ratings of these rated floor-ceiling and roof-ceiling assemblies.

INSTALLATION INSTRUCTIONS:

1. Before installing a model 55LP damper, open blades and hook fusible link over the link plates on each blade and bend down the catch to secure the link in position. With the 55EA damper, flex the spring wire and secure the link.
2. Measure the truss centers and add approximately 6" to determine mounting angle lengths (2 required per box).
 - *Option 1: Cut and bend the mounting angle on both ends to 90°, or appropriate angle required.
 - *Option 2: Use drive "S" locks.
 - *Option 3: Use 12 gauge wire and the provided hanger brackets.
3. Position the box at the correct location for gypsum installation and fasten to the angles with a minimum of (2) #8-#10x3/4" screws, 3/16" rivets or spot welds for each angle, ensuring the fastener does not interfere with the damper operation.
 - *Option 2: Install the drive "S" locks on the box flanges in place of the mounting angle.
 - *Option 3: Use 12 gauge wire to secure the box from structural members.
4. Mounting angles are fastened to the joists or other structural members with a minimum of (2) fasteners for each mounting location using #6 common nails or #8-#10x1-1/4" screws.
 - *Option 2: Fasten the drive "S" lock to joists or other structural members with a minimum of (2) of the specified fasteners.
5. The clearance between each side of the ceiling damper and the duct drop shall be a maximum of 1/8".
6. Steel or aluminum grille or diffuser to be attached to the duct drop or ceiling damper using #8x1/2" sheet metals screws and a minimum of (3) locations, ensuring the fastener does not interfere with the damper operation.



500 E. Eighth Street • Holland, MI 49423

T (800) 466-9374 • F (866) 466-9335 • www.wardind.com

Pg 591.7

11/14/05